



AE-21
Pages
1 to 16

Tonsil





HURD
AE-21-2101 21.0cm AE-21-2102

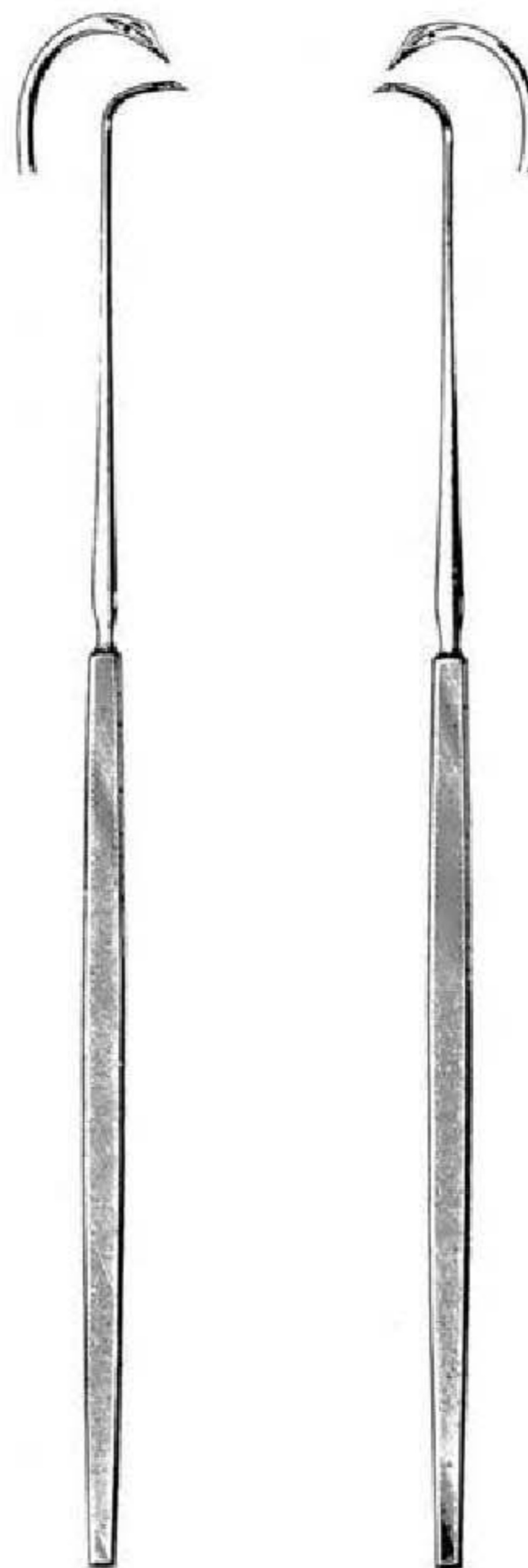

DURHAM
AE-21-2103 25.0cm AE-21-2104

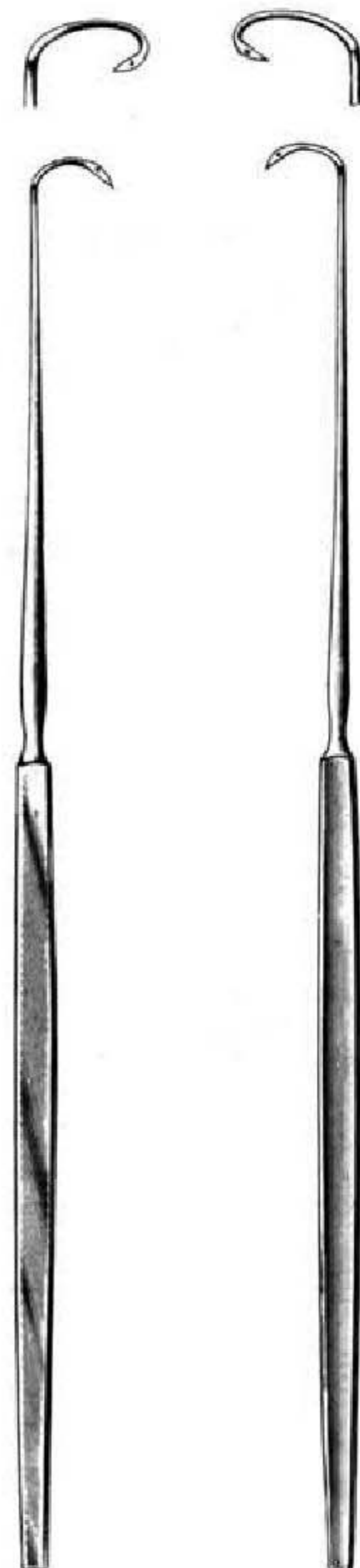

ROTTER
AE-21-2105 26.0cm AE-21-2106



NAGER
AE-21-2107 24.0cm

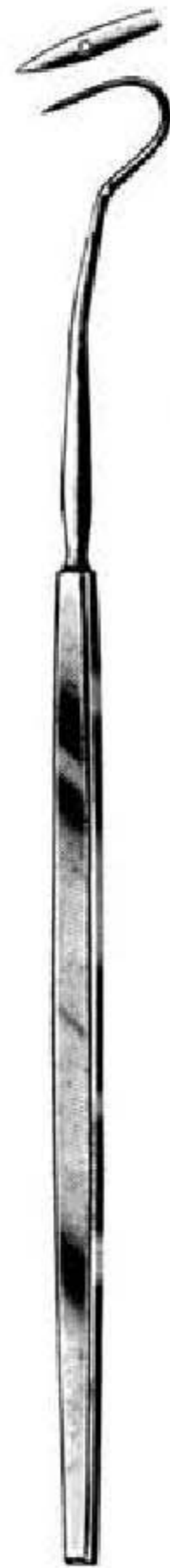

CLAUS-EICKEN
AE-21-2108 23.0cm

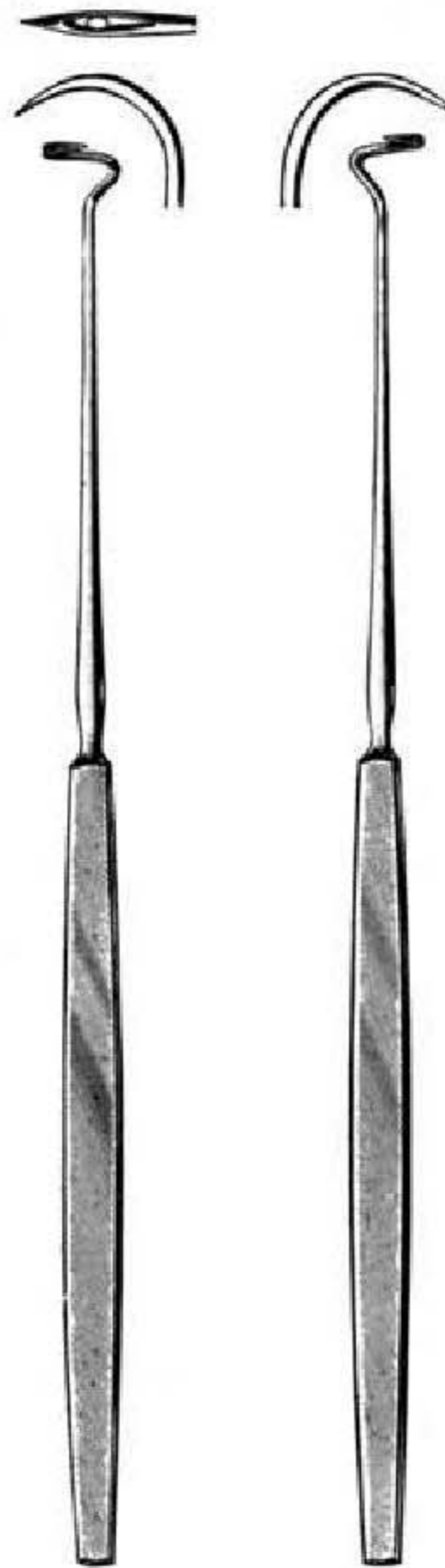

DUPUY-WEISS
AE-21-2109 22.0cm AE-21-2110



FALK
AE-21-2111 24.0cm AE-21-2112



BRUENINGS
AE-21-2113 23.0cm



ABRAHAM
AE-21-2114 21.0cm



FISHER
AE-21-2115 22.5cm



COLVER
AE-21-2116 22.5cm



DOUGLAS

AE-21-2117 21.0cm



CANFIELD

AE-21-2118 21.0cm



TYDING

AE-21-2119 21.0cm



LYNCH

AE-21-2120 20.0cm



DAY

AE-21-2121 21.5cm

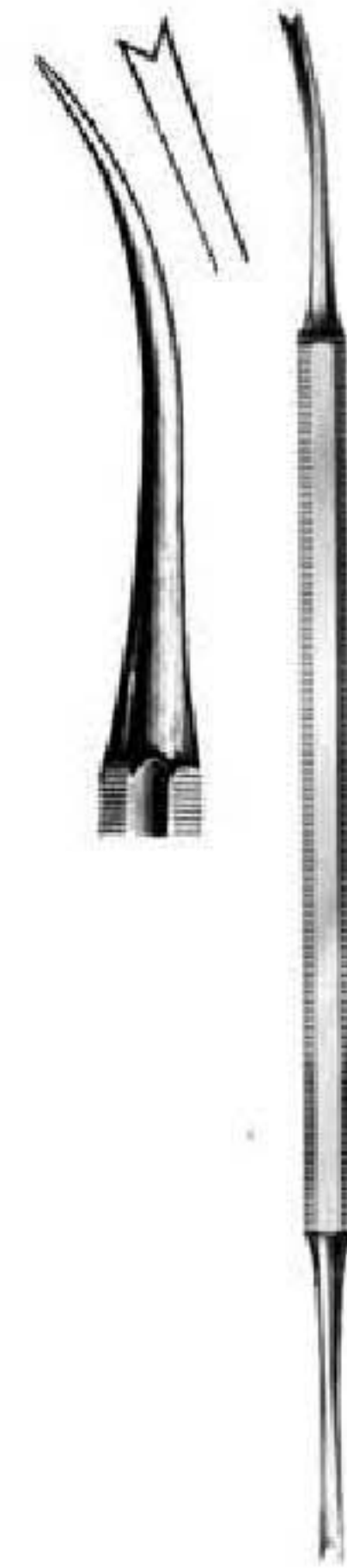

LUNIATSCHEK

AE-21-2122 19.0cm



HURD
AE-21-2123 22.5cm

HENKE
AE-21-2124 23.0cm

HENKE
AE-21-2125 23.0cm

CARPENTER
AE-21-2126 25.0cm

CARPENTER
AE-21-2127 24.0cm

Dissectores, Enucleator, Retractor etc.
 Dissektoren, E nukleator, Retraktor usw.
 Disecadores, enucleador, separador etc.

Tonsil

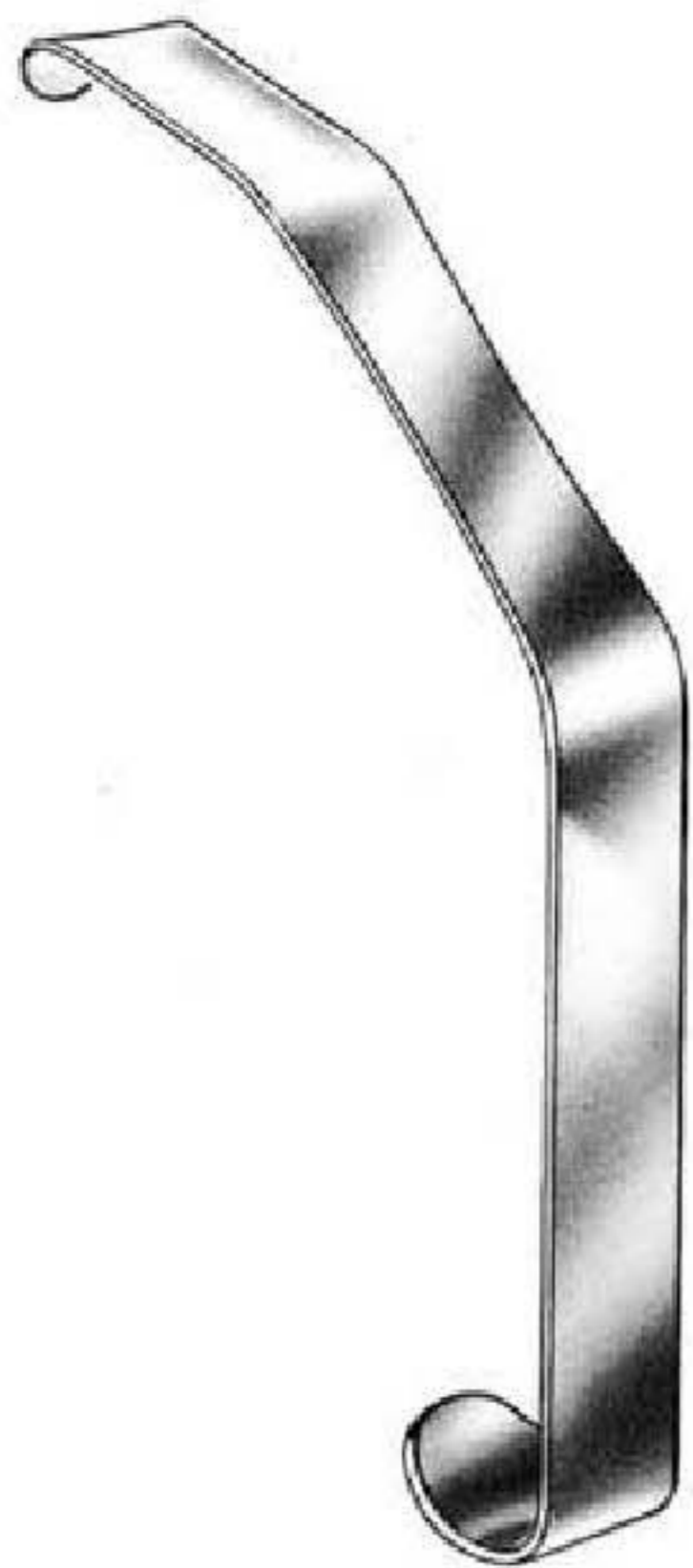

LOVE
15.0cm
 AE-21-2128.1 18mm
 AE-21-2128.2 20mm
 AE-21-2128.3 22mm

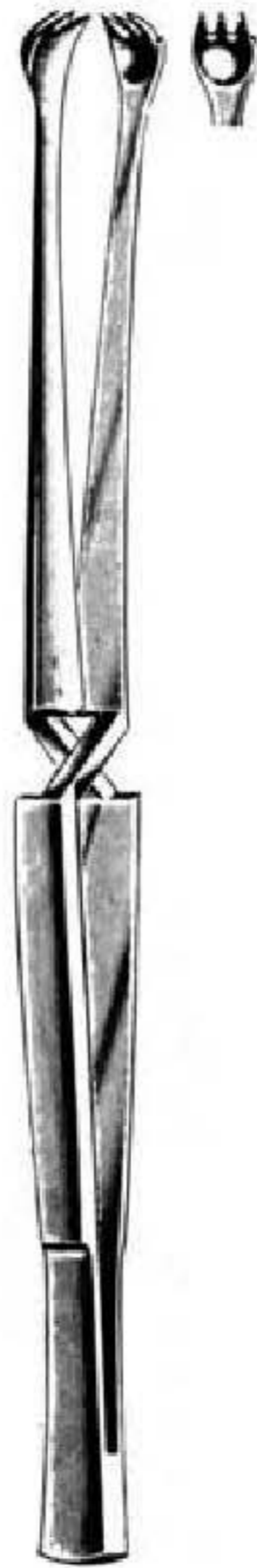

MARSCHIK
AE-21-2129 22.0cm

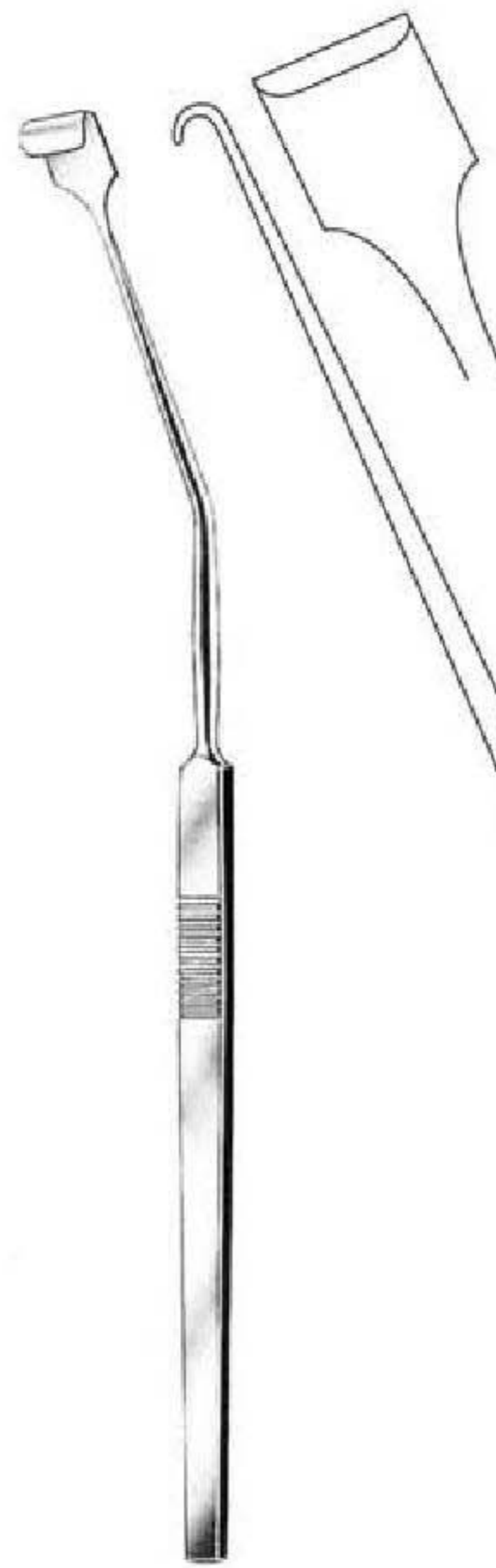

NAGER
AE-21-2130 24.0cm

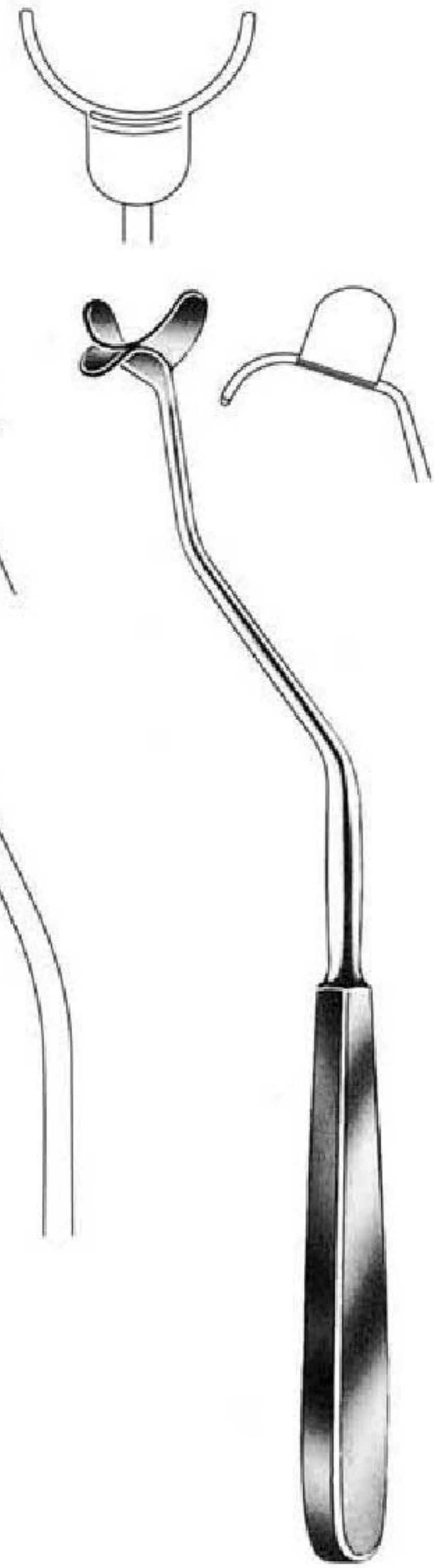

HOFER
AE-21-2131 24.0cm

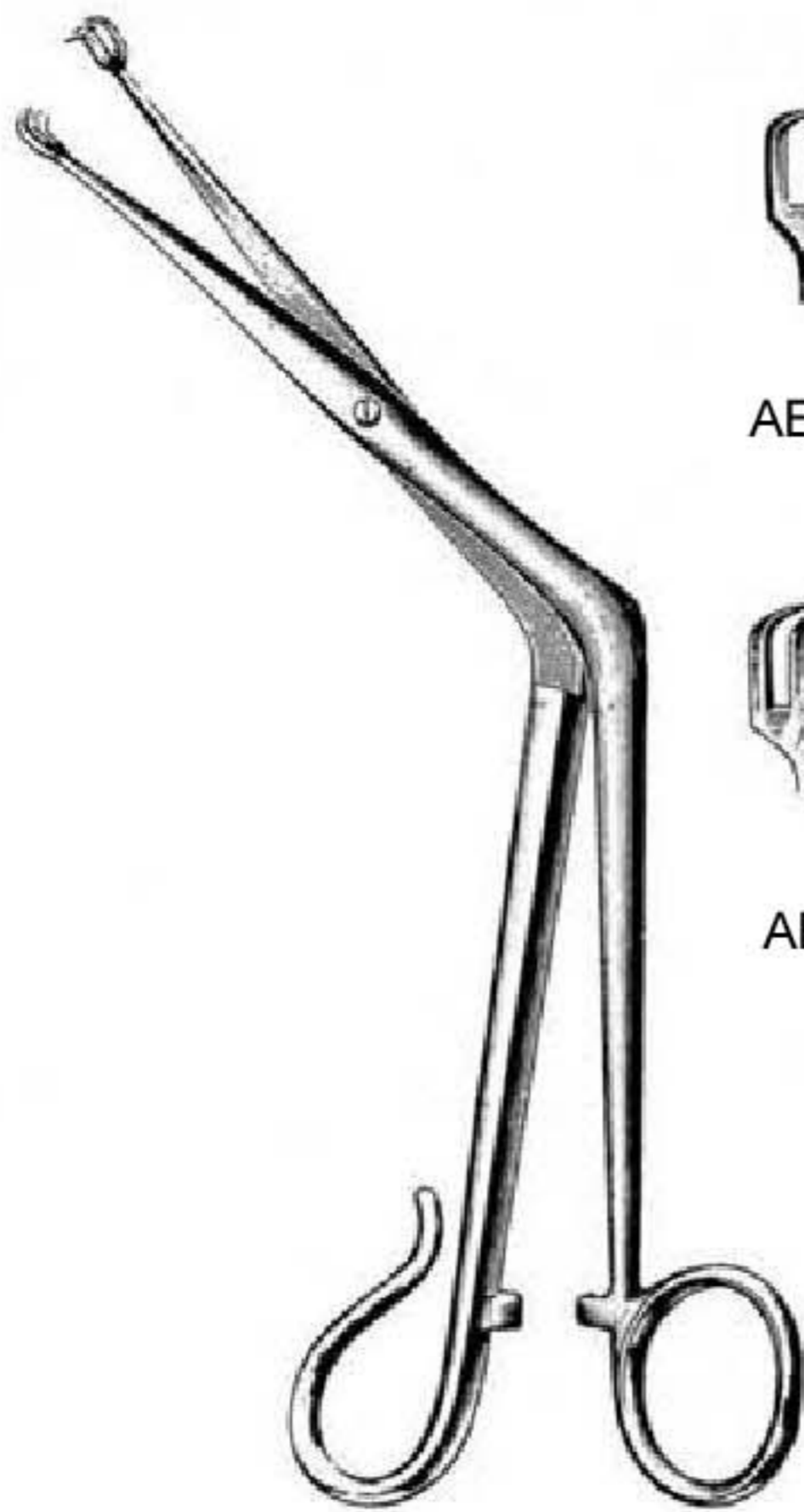

TIVNEN-TYDING
21.0cm

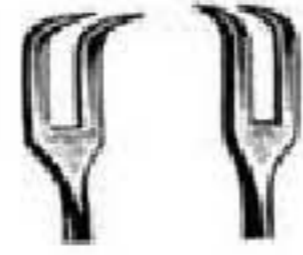

Fig.1
AE-21-2132.1

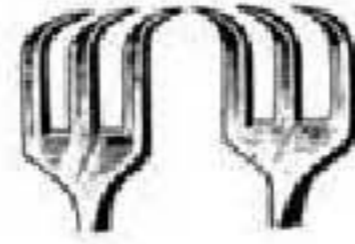
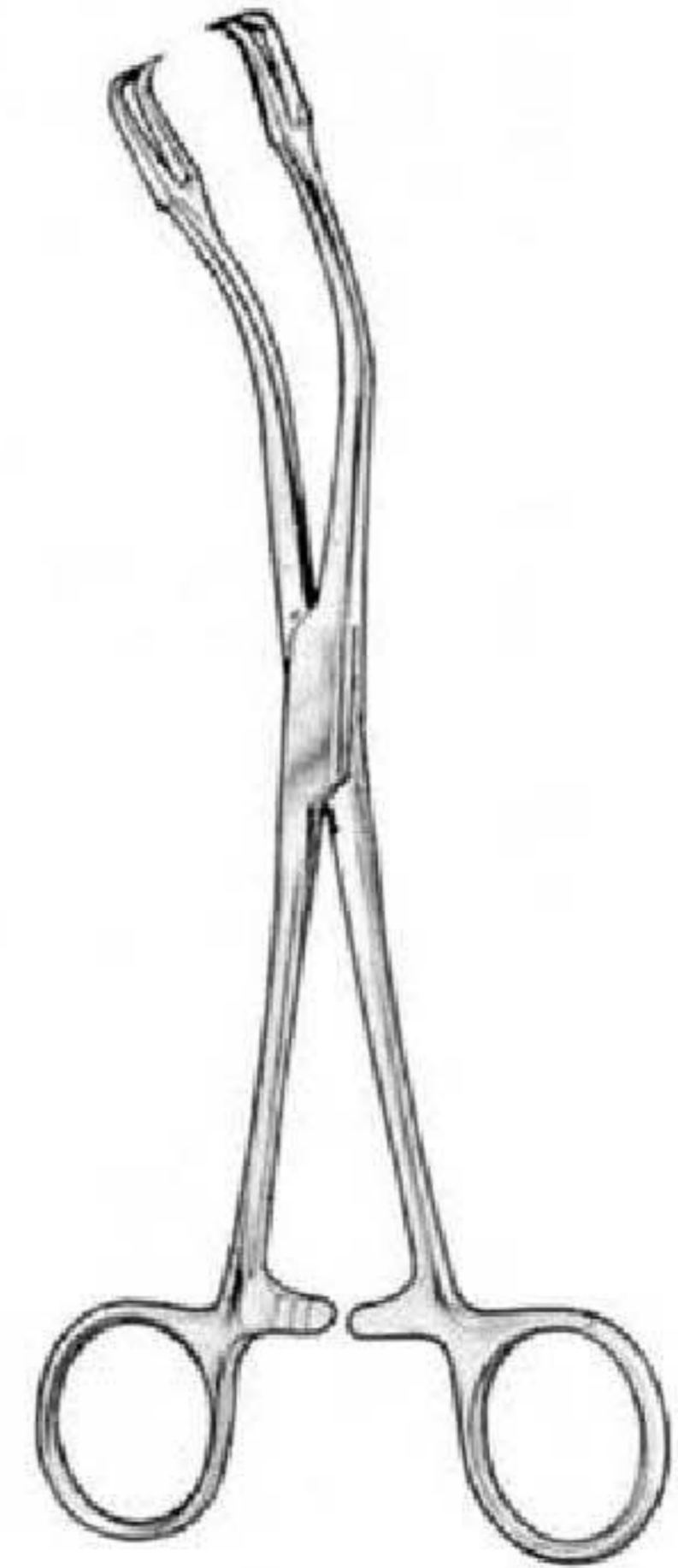

Fig.2
AE-21-2132.2



MUSEUX
AE-21-2133 20.0cm



MUSEUX
AE-21-2134 20.0cm



BALLENGER
AE-21-2135 21.5cm



WHITE
AE-21-2136.1 18.0cm
AE-21-2136.2 23.0cm



AE-21-2137.1



AE-21-2137.2

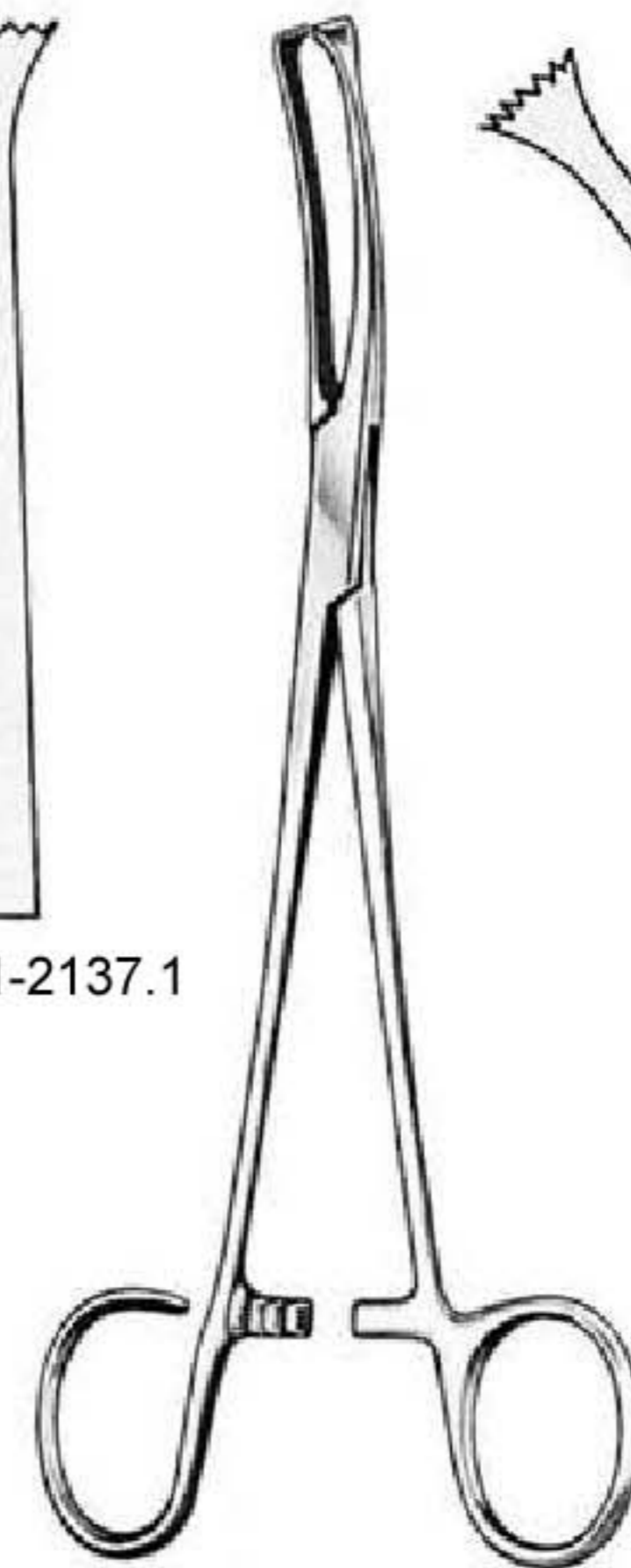

COLVER
19.0cm

Tonsil Haemostatic and Abscess Holding Forceps
 Tonsil Haemostatic und Abszessbesitzzange
 La amigdala haemostatic yel absceso que tienen fórceps

Tonsil

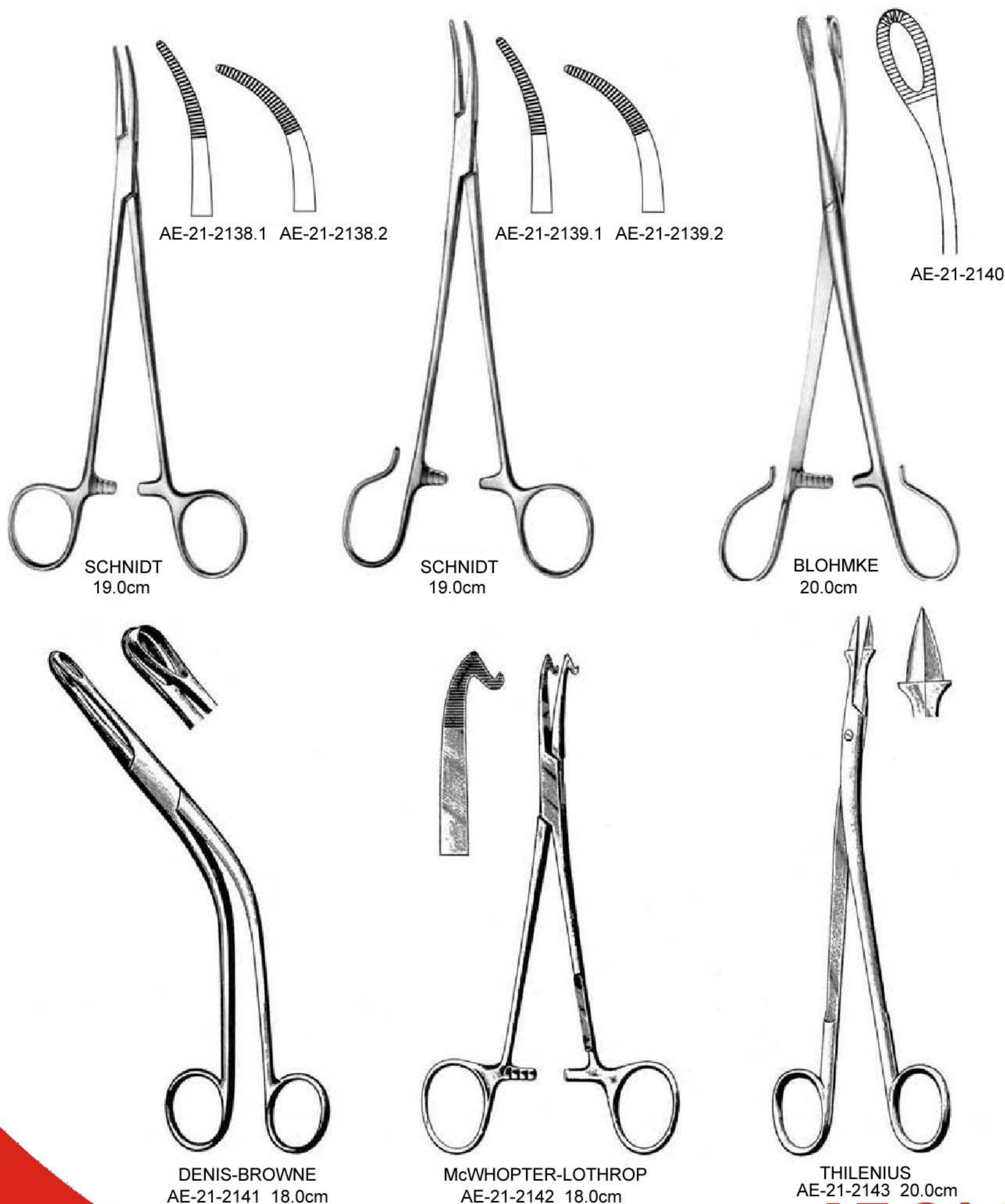

Tonsil Haemostatic Forceps

Tonsil Haemostatic zange

Pinzas de amigdala haemostatic

Tonsil



NEGUS
19.0cm

AE-21-2144.1 AE-21-2144.2

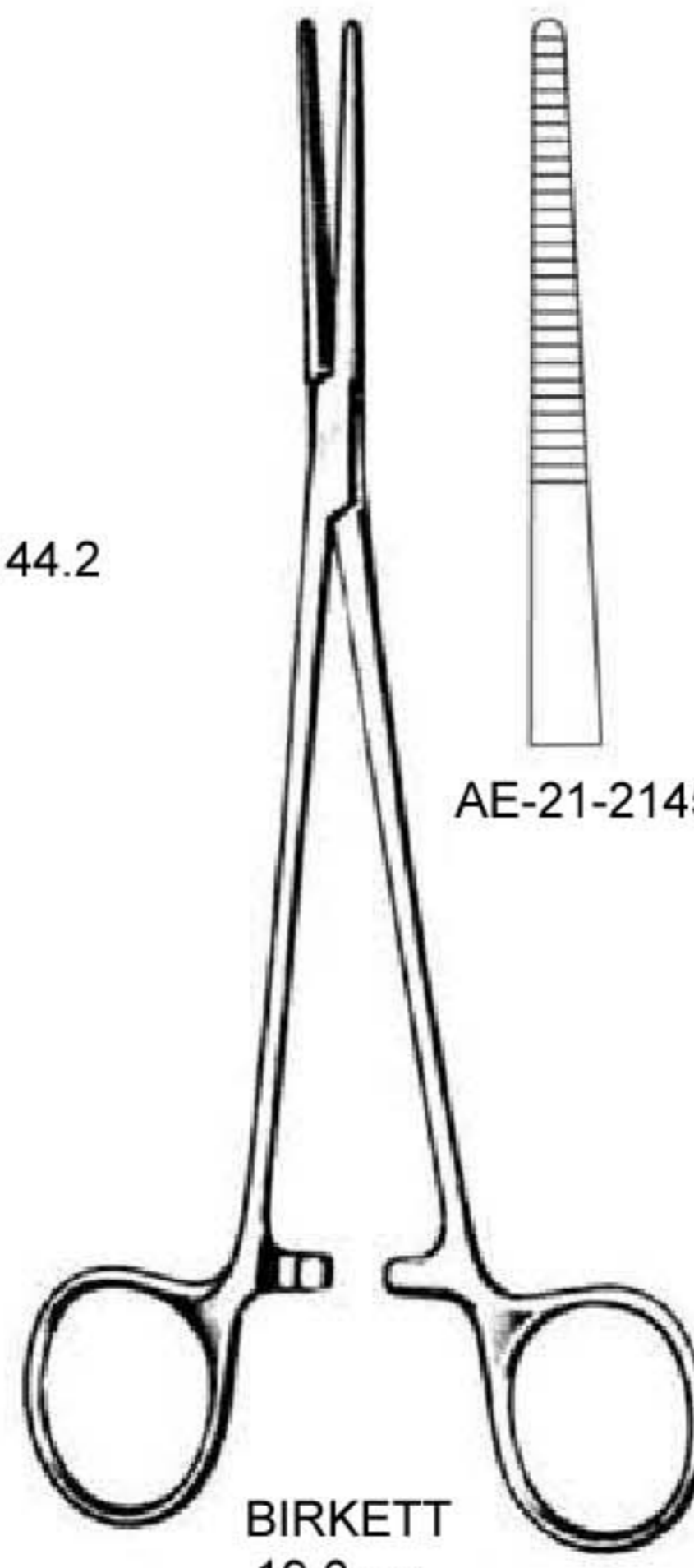

BIRKETT
19.0cm

AE-21-2145.1 AE-21-2145.2 AE-21-2145.3

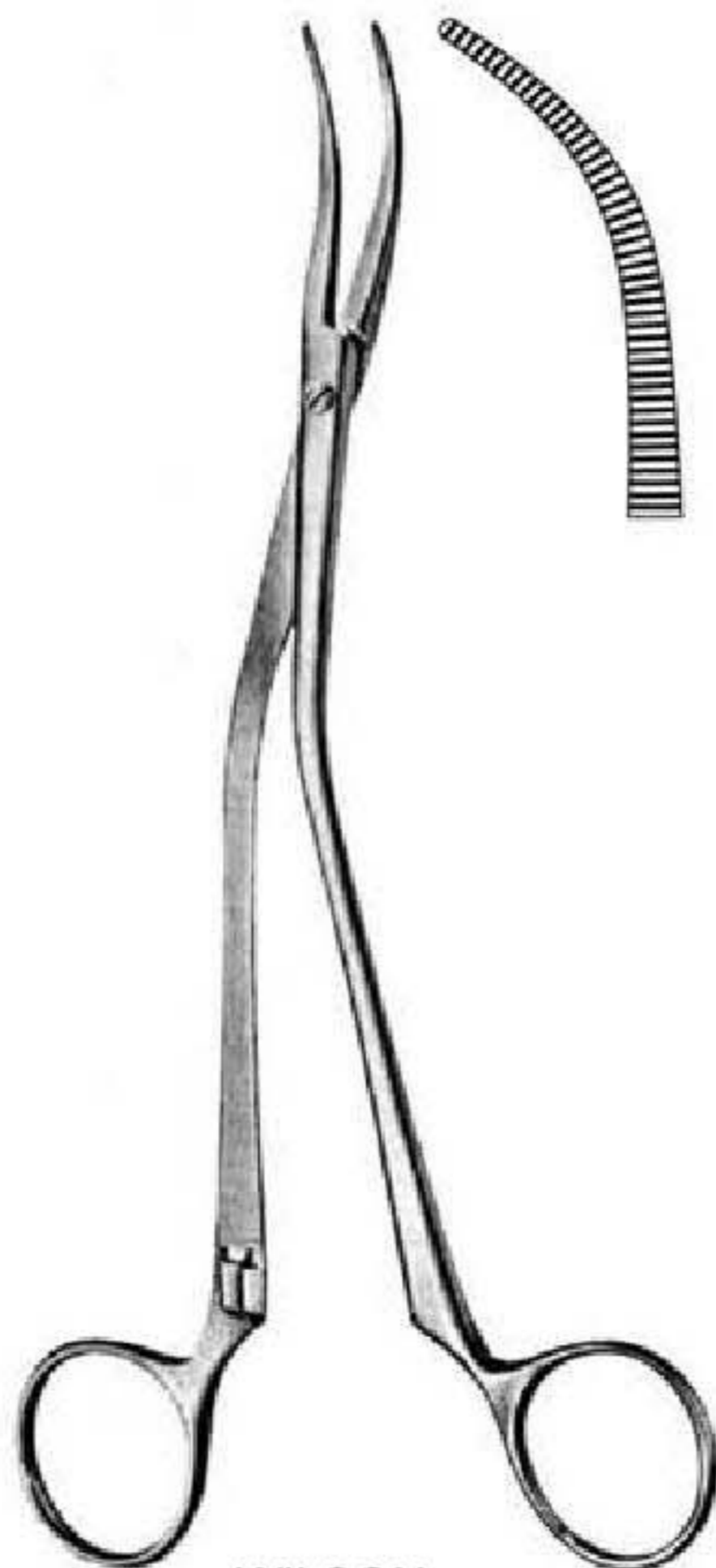

WILSON
AE-21-2146 19.0cm



MOLLISON
AE-21-2147.1 18.0cm (with horizontal opening)
AE-21-2147.2 18.0cm (with vertical opening)

AE-21-9

Tonsil Snares
Tonsillenschnürer
Cierra-nudos para amígdalas

Tonsil



EVES
AE-21-2148 28.0cm



EVES
AE-21-2149 28.0cm



BRUENINGS
AE-21-2150 28.0cm

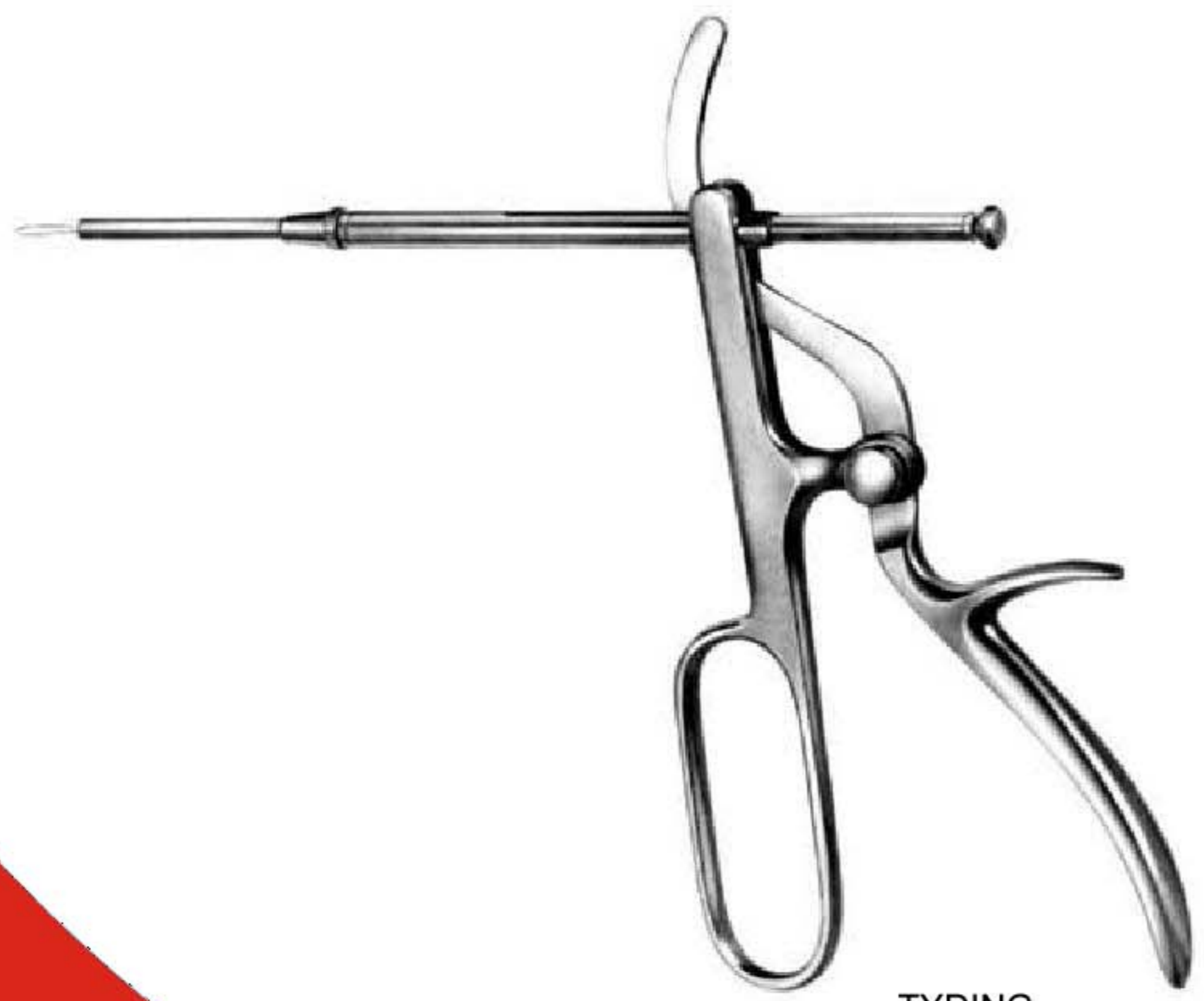

TYDING
AE-21-2151

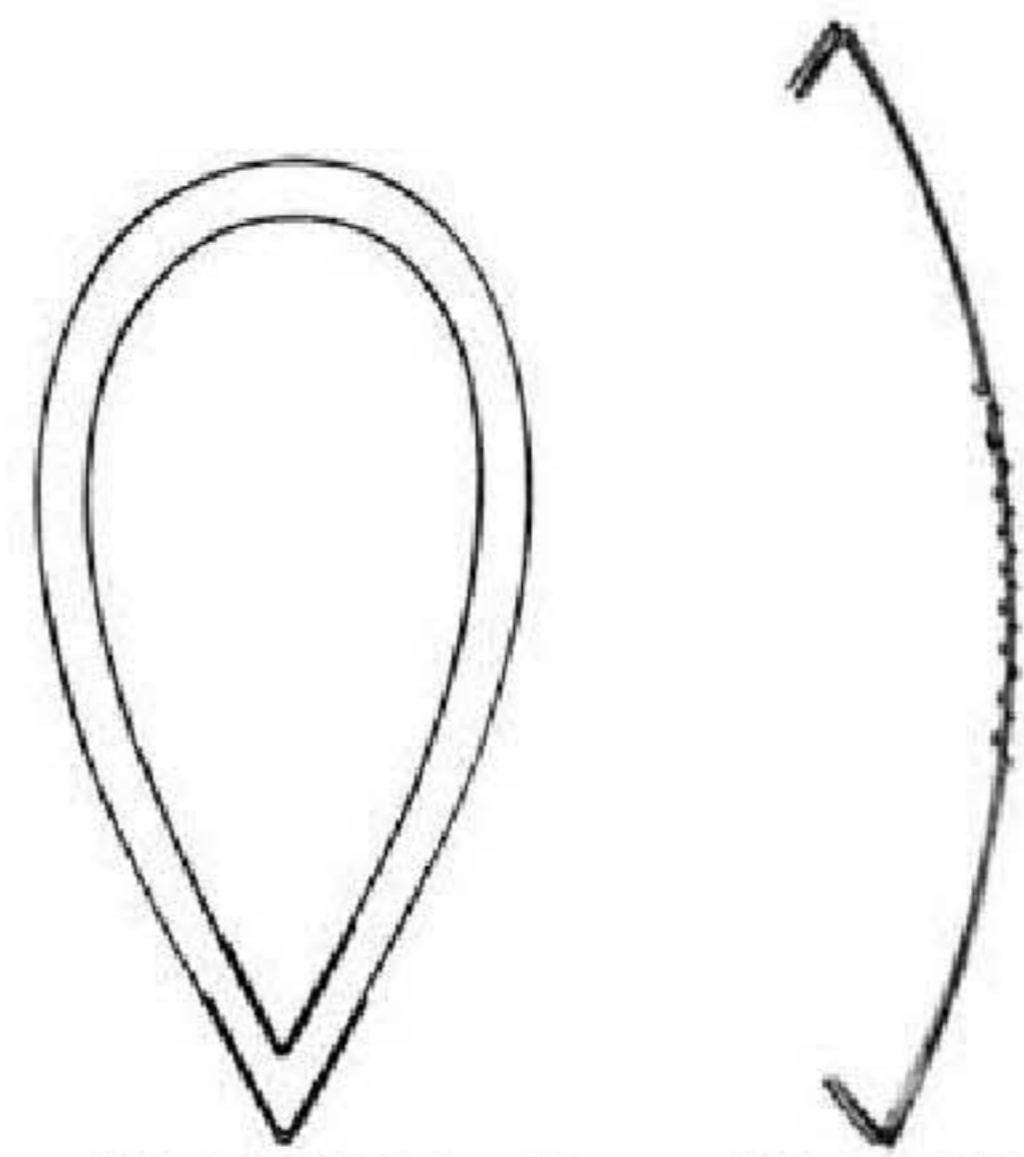

AE-21-2152.1 40mm AE-21-2153 0.3mm
AE-21-2152.2 50mm

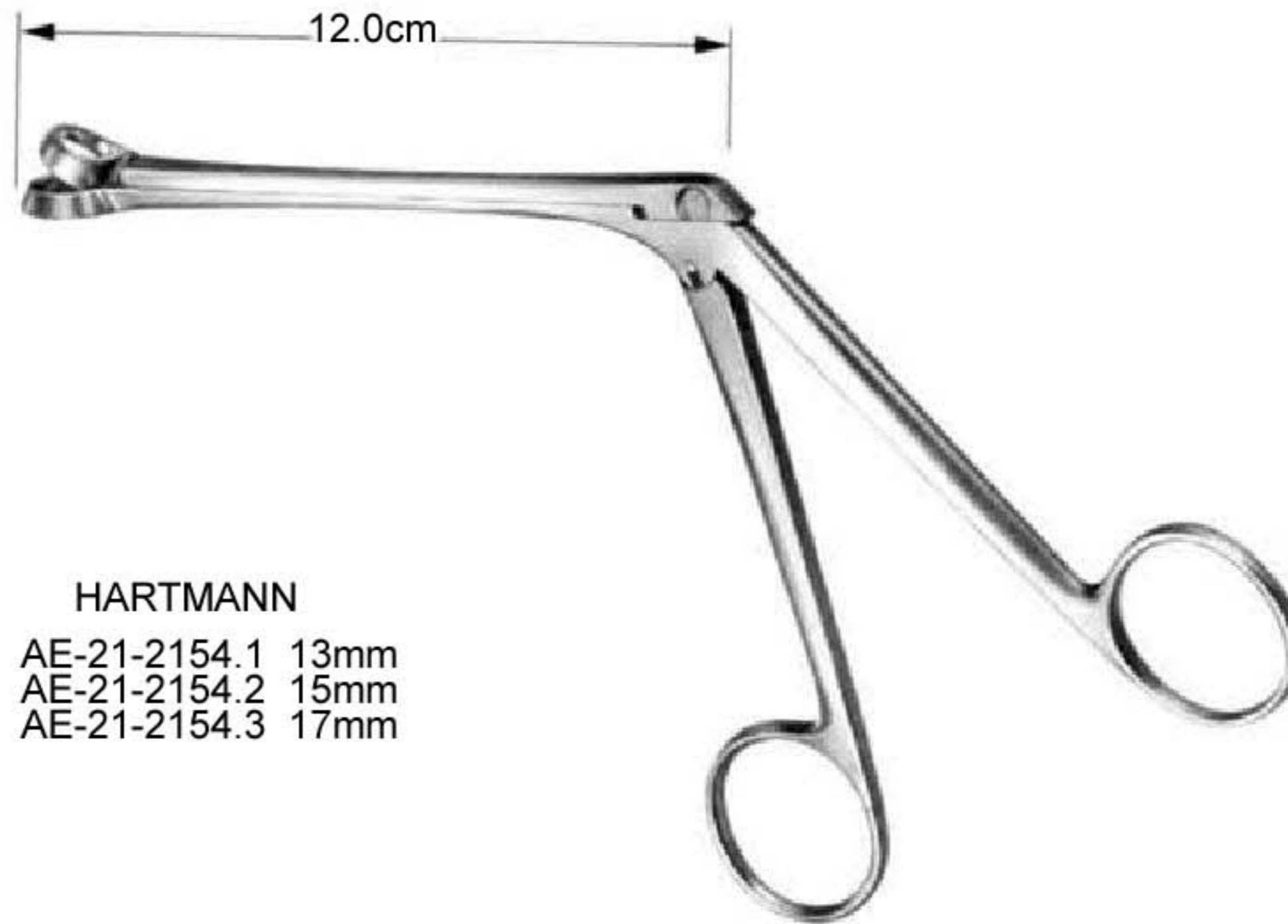

HARTMANN
AE-21-2154.1 13mm
AE-21-2154.2 15mm
AE-21-2154.3 17mm

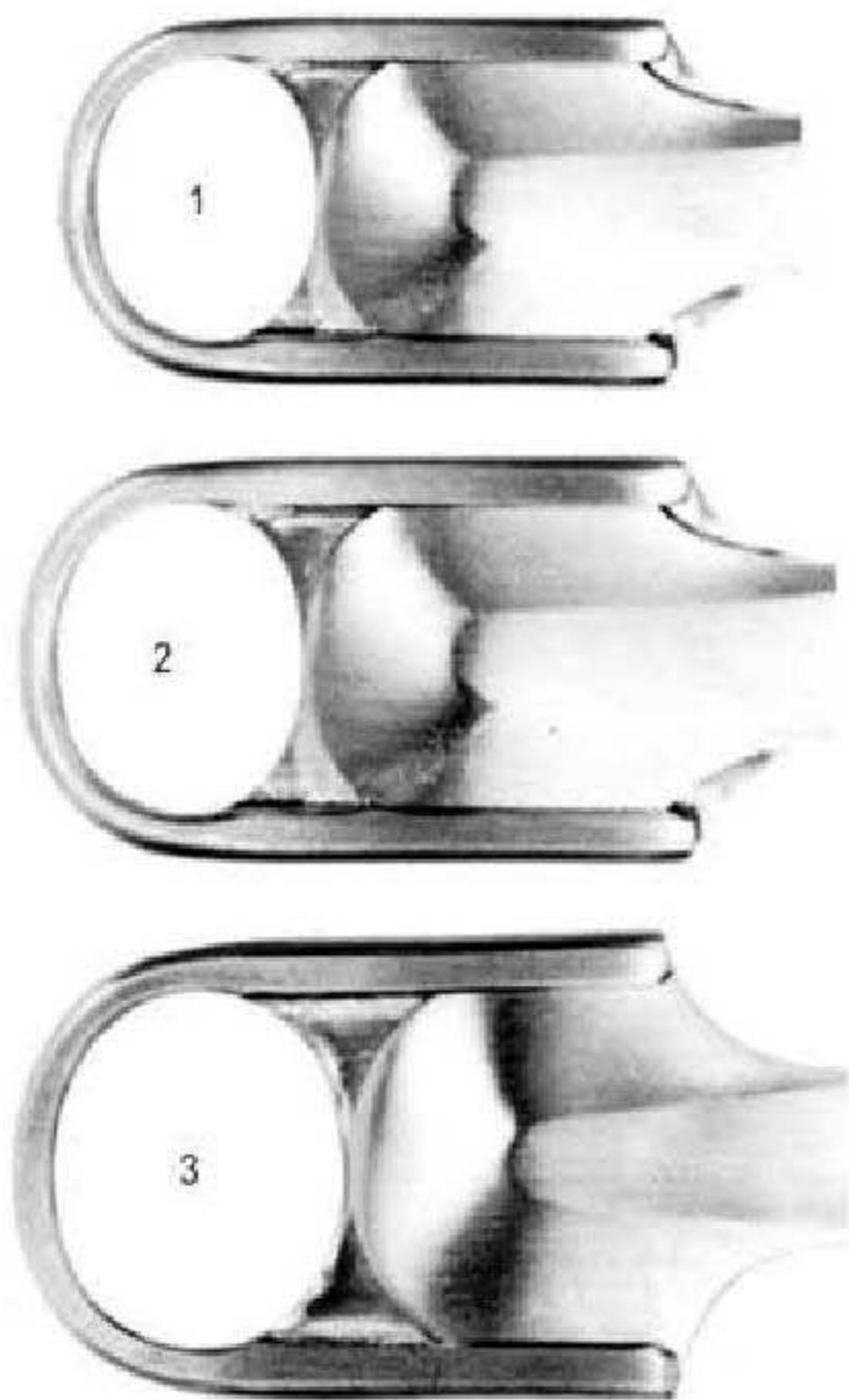

SLUDER-BALLENGER
complete 3-tips

- AE-21-2155.1
- AE-21-2155.2
- AE-21-2155.3

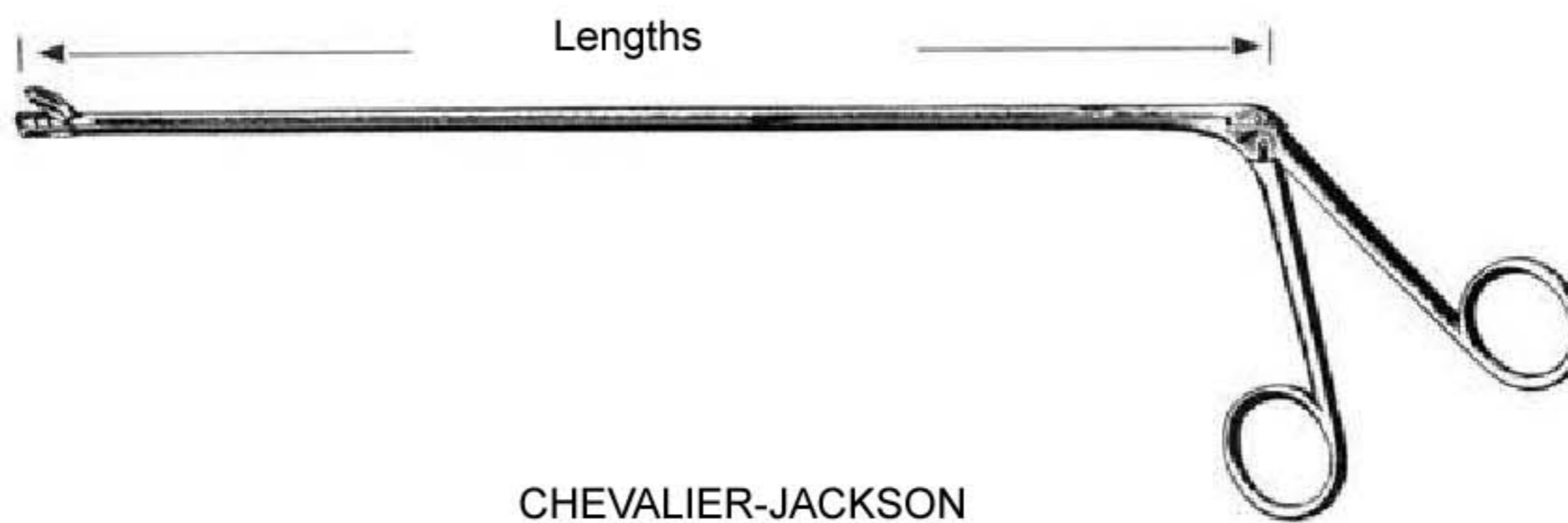

CHEVALIER-JACKSON



30.0cm	AE-21-2156	AE-21-2157	AE-21-2158	AE-21-2159	AE-21-2160	AE-21-2161	AE-21-2162
40.0cm	AE-21-2163	AE-21-2164	AE-21-2165	AE-21-2166	AE-21-2167	AE-21-2168	AE-21-2169
50.0cm	AE-21-2170	AE-21-2171	AE-21-2172	AE-21-2173	AE-21-2174	AE-21-2175	AE-21-2176
60.0cm	AE-21-2177	AE-21-2178	AE-21-2179	AE-21-2180	AE-21-2181	AE-21-2182	AE-21-2183



HUBER
AE-21-2184



BRUENINGS (straight)

AE-21-2184.1	20.0cm
AE-21-2184.2	30.0cm
AE-21-2184.3	40.0cm
AE-21-2184.4	50.0cm
AE-21-2184.5	60.0cm



BRUENINGS
AE-21-2185



BRUENINGS
AE-21-2186 20.0cm

AE-21-12



FRAENKEL
AE-21-2187.00



BARACANI
AE-21-2188.00



SEIFFERT
AE-21-2189.00



FRAENKEL
AE-21-2190.00



BRUENINGS
AE-21-2191.1
AE-21-2191.2



BRUENINGS
AE-21-2192.1
AE-21-2192.2



LANGE
AE-21-2193



KRAUSE
AE-21-2194.1
AE-21-2194.2



SCHUMACHER
AE-21-2195.00



CORDES
AE-21-2196.1
AE-21-2196.2



CORDES
AE-21-2197



ROSENBERG
AE-21-2198



KRAUSE
AE-21-2199

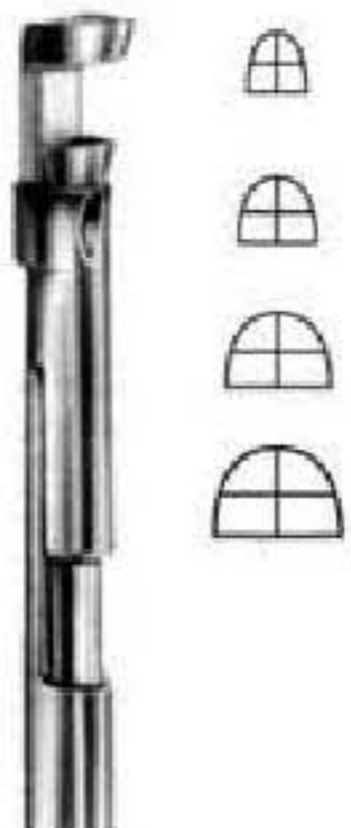

CORDES
AE-21-2200.1
AE-21-2200.2
AE-21-2200.3
AE-21-2200.4



SCHEINMANN
AE-21-2201



SCHEINMANN
AE-21-2202



AE-21-2203



AE-21-2204



AE-21-2205



AE-21-2206



AE-21-2207



MICHEL
25.0cm



AE-21-2208



AE-21-2209



AE-21-2210



AE-21-2211



AE-21-2212
AE-21-2214
AE-21-2216
AE-21-2218
AE-21-2220
AE-21-2222
AE-21-2224
AE-21-2226
AE-21-2228
AE-21-2230
AE-21-2232
AE-21-2234

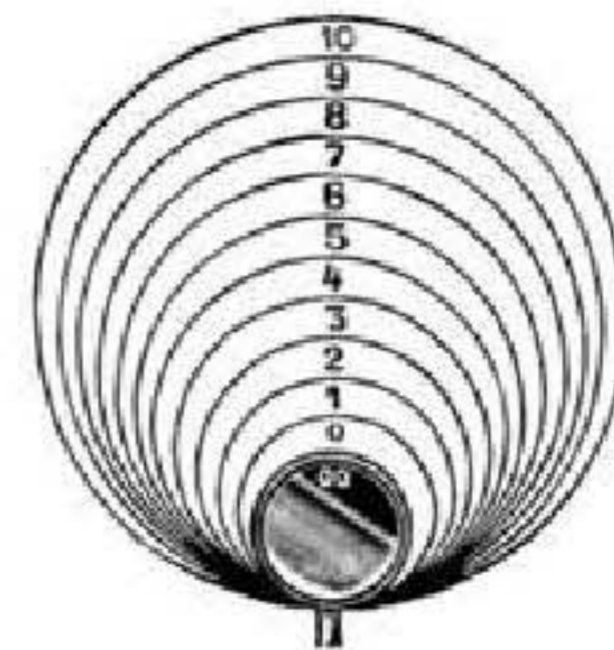

fig.00, 8mm
fig.0, 10mm
fig.1, 12mm
fig.2, 14mm
fig.3, 16mm
fig.4, 18mm
fig.5, 20mm
fig.6, 22mm
fig.7, 24mm
fig.8, 26mm
fig.9, 28mm
fig.10, 30mm



AE-21-2213
AE-21-2215
AE-21-2217
AE-21-2219
AE-21-2221
AE-21-2223
AE-21-2225
AE-21-2227
AE-21-2229
AE-21-2231
AE-21-2233
AE-21-2235

Laryngeal Polypus Forceps, Epiglottis Retractor, Tampon Forceps
Kehlkopfpolypenzangen, Deckelhalter, Tamponpinzetten
Pinzas para polipos laringeos, depresor para epiglottis, pinzas para toponamientos

Tonsil



AE-21-2236.1



AE-21-2236.2



AE-21-2236.3



AE-21-2236.4

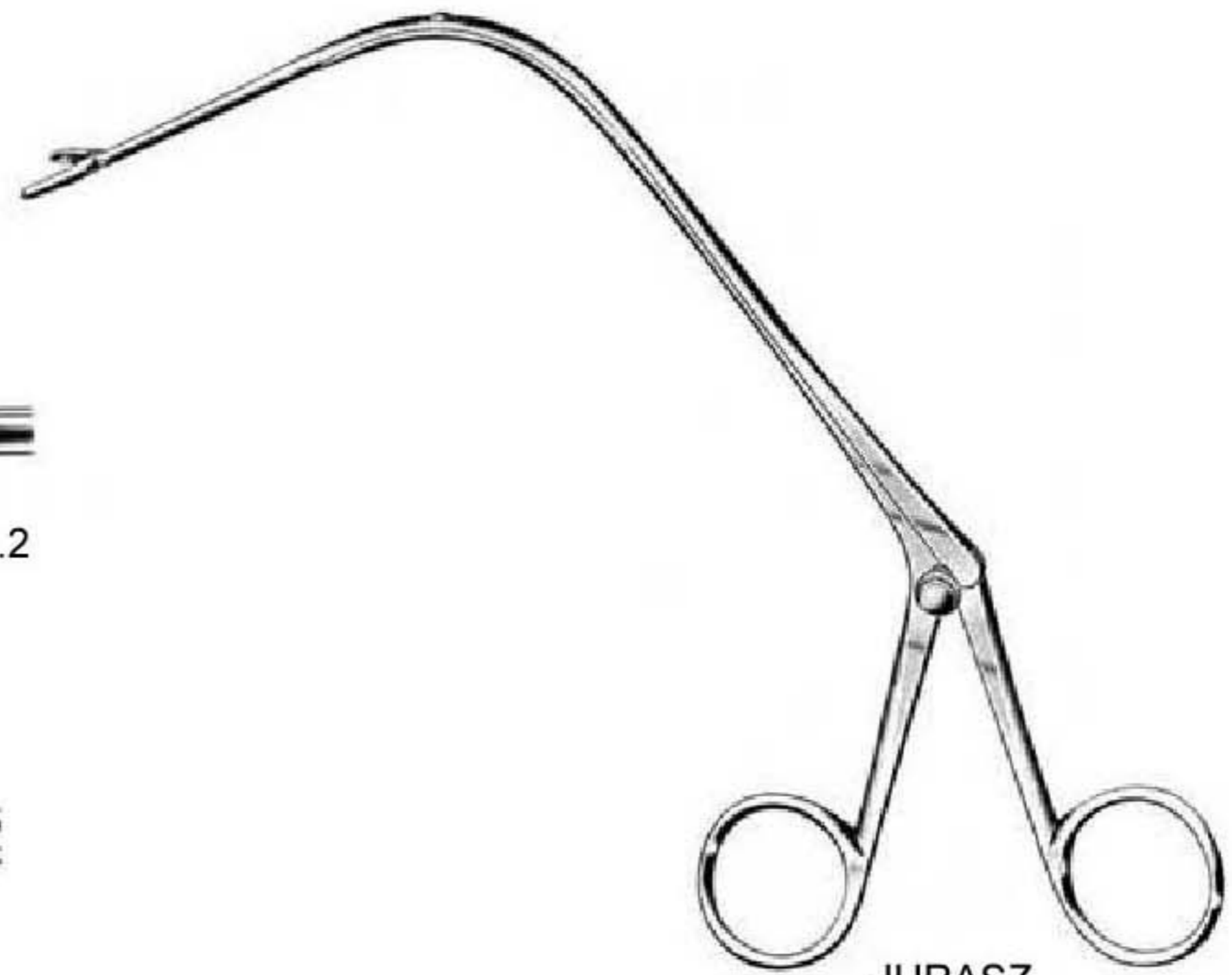

JURASZ
23.0cm

Tonsil

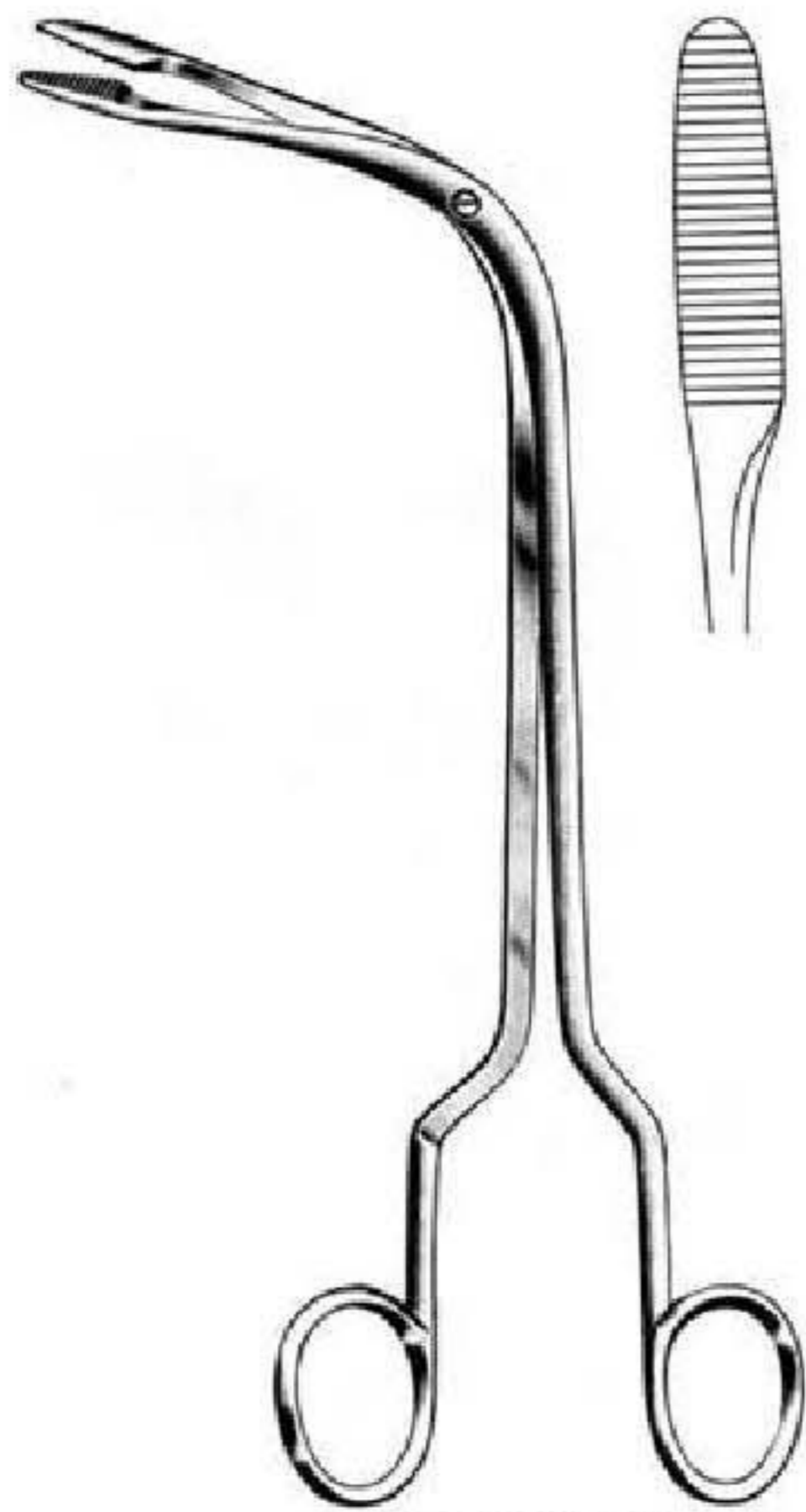

FRAENKEL
AE-21-2237 19.0cm



JACKSON
22.0cm

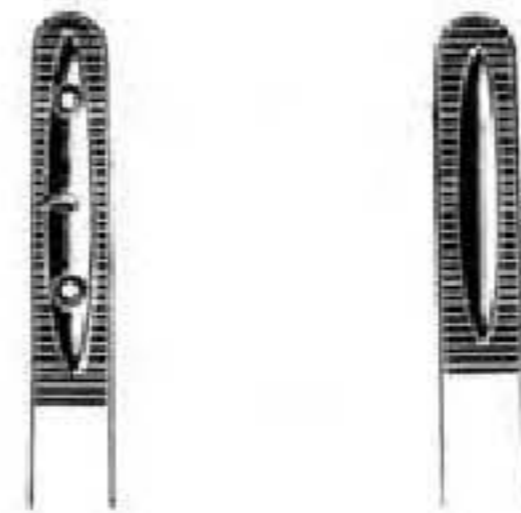

AE-21-2238.1 AE-21-2238.2



REICHERT
AE-21-2239 24.0cm